

ACE V Sensors

Vibration Sensors for Process Monitoring

Process monitoring becomes more and more important in the field of automation. Permanent process monitoring recognizes and localizes malfunctions in the automation process early, thus preventing expensive repair, maintenance and downtimes. These new, innovative ACE vibration sensors support the field of pick and place technology and automation, e.g., in linear



modules, rotary actuators and grippers. The sensors are positively connected with the device (e.g., C-slot) and permanently take up the vibration level during the work process.

If an increase of vibrations caused by an overload, varying drive power and decreasing damping performance above the preset nominal value is detected, the sensor changes its switching status to open or close, depending on the design. The process is interrupted via the connection to the monitoring system. Expensive repair and maintenance costs can thereby be avoided.

The new ACE sensors are available in versions PNP, NPN and analogue.



Red LED lights up



Green LED lights up

Dimensions

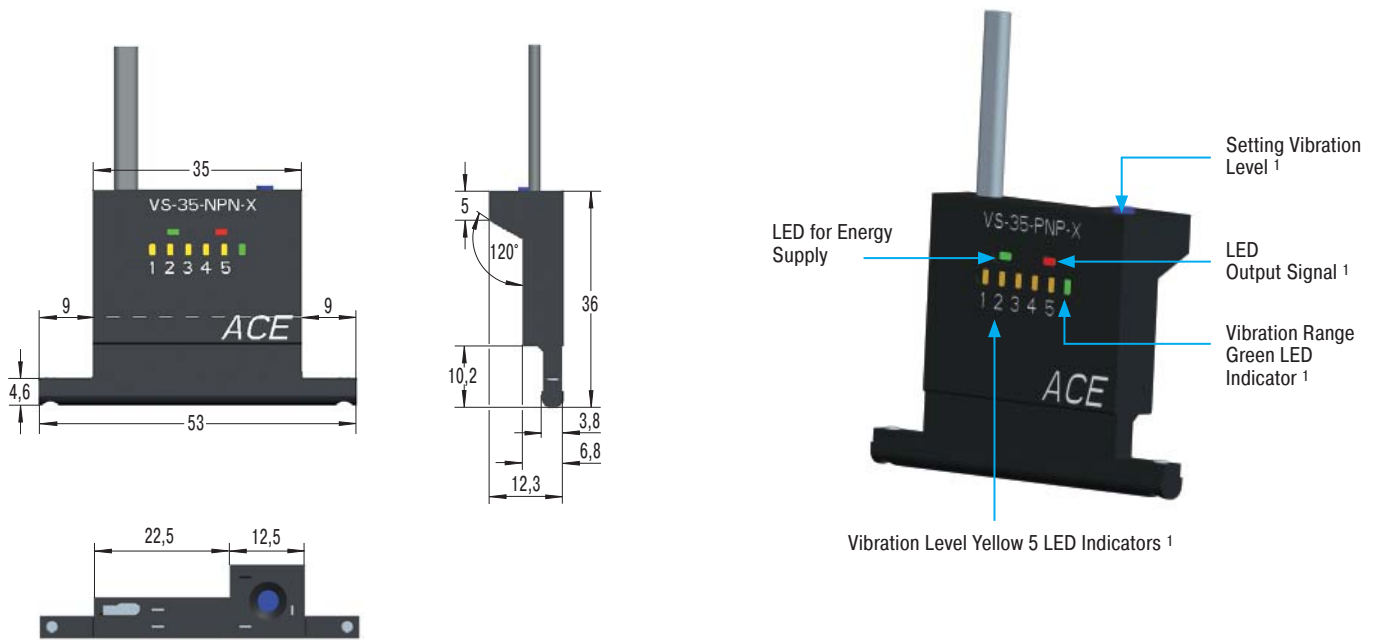

¹ Not applicable for analogue version.

Type: VS-35-A-X

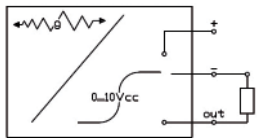

Type: VS-35-A-Y

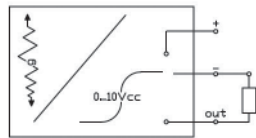

Analogue 0 – 35 g (~270 mV/g)
 Measuring range: 35 g
 Power supply: 12 – 30 VDC
 Max switching current: 0,2 A
 Voltage drop: max. 2 V
 Environmental protection degree: IP 67
 Polarity reversal protection: yes
 Operating temperature range:
 -10° C to +60° C
 Cable length: ca. 2500 mm

Type: VS-35-PNP-X

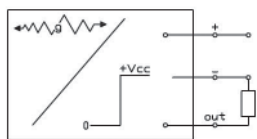

Type: VS-35-PNP-Y

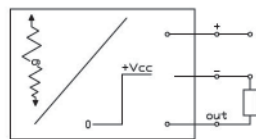

PNP switching (ten-stage adjustable)
 Measuring range: 35 g
 Power supply: 12 – 30 VDC
 Max switching current: 0,2 A
 Voltage drop: max. 2 V
 Environmental protection degree: IP 67
 Polarity reversal protection: yes
 Operating temperature range:
 -10° C to +60° C
 Cable length: ca. 2500 mm

Type: VS-35-NPN-X

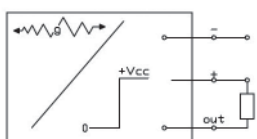

Type: VS-35-NPN-Y

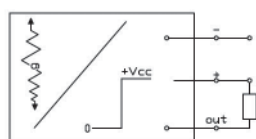

NPN switching (ten-stage adjustable)
 Measuring range: 35 g
 Power supply: 12 – 30 VDC
 Max switching current: 0,2 A
 Voltage drop: max. 2 V
 Environmental protection degree: IP 67
 Polarity reversal protection: yes
 Operating temperature range:
 -10° C to +60° C
 Cable length: ca. 2500 mm